

Swing flat press



Installing your Flat Press:

Remove all packaging materials and check the machine to ensure no damage has occurred during transit. We recommend when transporting the flat press to let the machine cool and lower the handle to the locked position. Never carry the machine by the handle.

70-1003

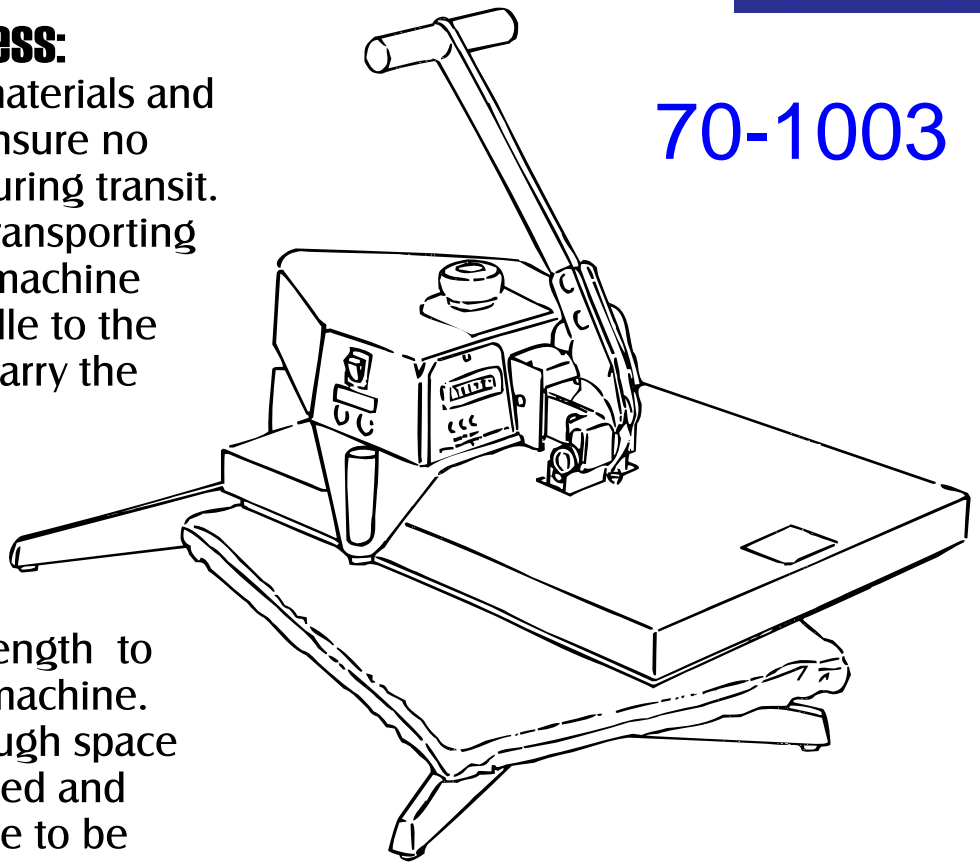

The machine needs to operate on a horizontal surface. The surface must have sufficient strength to hold the weight of the machine. There must also be enough space for the handle to be raised and lowered and for the plate to be moved to one side. Remember, the machine reaches high temperatures, so should not be located close to any substance that is vulnerable to heat.

Dimensions: *15"x20"*

Height (open)	65 cms
Height (closed)	35 cms
Length	51 cms
Width	38 cms

Specifications:

Power Consumption	2500 watts
Power Supply	240 volts AC
Working Temperature	70-235° C
Net Weight	45 KG
Fuses	12.5 A

Swing flat press

Continued

Press Operation:

- Plug the press into the supply outlet
- Ensure the press is in the 'unlocked' position (the heat plate and pad are not in contact)
- Turn the on/off switch to the 'On' position
- Adjust the pressure. The pressure can be adjusted by turning the adjustable handle on the top of the machine - turn clockwise to increase the pressure and anticlockwise to decrease it*. Do not adjust the pressure when the machine is clamped shut. Never increase the pressure so that there is unnecessary force on the heat plate.
- The heat plate must always be in the raised position before the controller is set.
- Adjust the timer. Press the mode button on the control unit and then adjust the time with the up and down buttons* See the diagram on page 8.
- Adjust the temperature. Press the mode button on the control unit and then adjust the temperature with the up and down buttons* Press mode again until the flashing stops. See the diagram on page 8
- Wait for the press to heat to the correct temperature
- Swing the heat plate head away from the table pad
- Place the product to be printed on the table pad (remember, a garment can be slipped over the pad so just a single layer is pressed.)
- Position the transfer on the material (when using a printed transfer - it is suggested an application paper is also used)
- Swing the head back over the pad using the handle, push the heat plate down on the pad.
- Lock into position
- The timer buzzer will sound (from already being pre-set)
- Unlock the heat plate by pulling the release knob on the side of the machine and then raise the handle

Swing flat press

Continued

Hints and Tips for Flat Press

- Always switch off your heat press when administering any maintenance or cleaning.
- Leave the press 'unlocked' when not actively pressing
- Do not touch any internal parts of the machine
- Do not carry the heat press by the handle
- Do not increase the pressure so that there is unnecessary force on the heat plate

If the transfer fails to adhere to the product check:

- The heat, time and pressure settings are correct.
- The transfer is in contact with the pressing pad and the heat plate.
- The pressing pad is in good condition and that it is flat, making complete contact with the whole of the plate.

By accepting delivery of this flat press the customer acknowledges that they have read and understood these guidance notes. The customer further accepts that neither Mega Electronics Limited nor any of its representatives will be in any way liable for any injury to any person or loss of or damage to any property arising as a result of use of this flat press other than in accordance with these guidance notes.



MEGA ELECTRONICS LIMITED.,
Mega House, Grip Industrial Estate, Linton, Cambridge, CB21 4XN
Telephone: +44 (0) 1223 893900 Fax: +44 (0) 1223 893894
email: sales@megauk.com web: www.megauk.com

Swing flat press

Continued

Time and Temperature Settings

(The head must always be in the up position before the controller is set.)

1

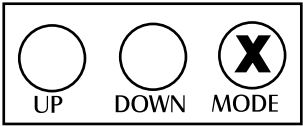

UP DOWN MODE

To set the time:
Press the MODE button once

2

TEMP	TIME	
	0	25
	M	SEC

The display will now show

3

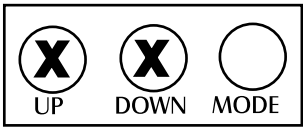

UP DOWN MODE

Use the UP & DOWN buttons to set the desired time within the range of 0 to 9 mins 59 secs

4

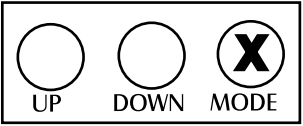

UP DOWN MODE

Now press the MODE button, this will save the set time and put the controller into the set temperature mode

5

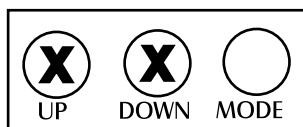

UP DOWN MODE

Use the UP & DOWN buttons to set the desired temperature within the range 70-235°C (158°F-455°F)

6

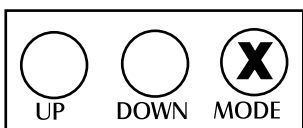

UP DOWN MODE

Press the MODE button once, this will save the temperature and return the controller into its normal operating condition

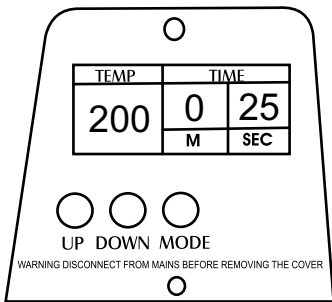

Normal Display