

ABC

Through Hole Plating Line

Through Hole Plating Line



ABC Through Hole Plating Lines

PL903S (Mega Part No: 500-085)
ABC COPPER PLATING LINE 12" x 10" (1 x 50A PSU)

&

PL904S (Mega Part No: 500-086)
ABC PLATING LINE 12" x 18" (1 x 100A PSU)

Panel Plating Instruction Manual

Updated: March 2013

IMPORTANT

ELECTRICAL SAFETY NOTICE

CONNECTIONS TO MAINS ELECTRICAL SUPPLY

This equipment is designed to safety class 1.

Before connecting this equipment to the mains electricity supply, examine the information on the apparatus rating label.

Ensure that the mains supply is single phase alternating current (ac) of the stated frequency (Hz), with neutral nominally at earth potential.

Check that the supply voltage is in the range stated on the rating label.

The equipment rating label states the value of the fuse fitted to the apparatus itself. Ensure that the plug or outlet circuit is fitted with an appropriate fuse of higher value.

WARNING: THIS APPARATUS MUST BE EARTHED

The wires in the mains lead are coloured in accordance with the following code:

Green/Yellow	-	Earth (E)
Blue	-	Neutral (N)
Brown	-	Live (L)

Connect the wires to a non-reversible 3 pin plug as follows:

Green/Yellow wire to terminal marked :	E (earth)	or
	G (ground)	or
	Coloured Green	or
	Coloured Green/Yellow	or

Blue wire to terminal marked :	N (neutral)	or
	Common	or
	Coloured Blue	or

Brown wire to terminal marked :	L (live)	or
	Phase	or
	Coloured Brown	

LIVE PARTS SHOULD NEVER BE EXPOSED UNLESS THE EQUIPMENT HAS BEEN SWITCHED OFF AND ISOLATED FROM THE MAINS ELECTRICITY SUPPLY.

CORRESPONDENCE

In the event of any correspondence concerning this equipment, please quote the catalogue number and serial number shown on the rating label together with the voltage and frequency of the local mains electricity supply. This will help to process your enquiry quickly.

Any spare parts which may be required, are supplied on the understanding that the replacement of these requiring the exposure of live electrical connections will be undertaken by an electrically qualified person.

Motor driven appliances should not be run unless all covers have been properly replaced.

SITING AND SETTING UP

A) To Site

Position the plating unit in a well ventilated area with access to mains cold water inlet supply and drain and near a 13 amp single phase 50Hz 220/240v a.c. supply socket.

B) Contents

The **PL903S /PL904S** should include the following:-

1	1 x	<i>PL903S /PL904S Plating Line</i>
2	1 x	<i>Oscillating Frame</i>
3	1 x	<i>Washing Machine Hose</i>
4	1 x	<i>Washing Machine Tap</i>
5	5 x	<i>Lids to cover Tanks when not in use</i>
6	2 x	<i>Board Holders</i>
7	1 x	<i>Set of Operating Instructions</i>
8	1 x	<i>Bag of Plastic balls to cover Copper Plating Solution.</i>
9	1 x	<i>32mm push fit T piece with blanking plug.</i>
10	4 x	<i>Anodes with hooks and Anode bags.</i>

C) Electrical Requirements

A single 13 amp 220/240v 50Hz single phase socket will be required. It must be properly earthed and it is recommended that an earth leakage (RCD) device should be fitted in case of heater breakage - available from us if required (part number 161053)

D) Mains Water Supply (Spray Wash)

The plating unit is supplied with a washing machine hose and threaded washing machine type tap. One end of the hose is connected to the mains water inlet at the back of the unit and the other end is connected to the threaded end of the tap which should first be fitted to a standard 15mm copper pipe supplying cold water at a minimum pressure of 1.5 Bar by means of its compression type fitting.

E) Water Waste Outlet (Spray Wash)

The unit is supplied with a standard 32mm push fit type T piece with a blanking plug in one side of the T. From here the unit can be plumbed into a suitable drain using standard 32mm polypropylene pipe and push fit joints.

N.B. If you experience difficulty getting the pipe or joints we can supply these.

N.B. ALWAYS ENSURE THAT ALL TANKS ARE FILLED WITH EITHER WATER OR PROCESSING CHEMICALS BEFORE CONNECTING TO THE MAINS ELECTRICAL SUPPLY

F) Pre-Test

In order to ensure the unit has suffered no damage in transit it is best to test the unit with water first prior to filling the tanks with chemicals.

For This Reason:

1) Fill each tank with water to 10mm from shoulder where the lid sits on and in the case of the plating bath unhook and remove anodes and then fill the tank with water so that the level is just below the bottom of the two vertical pillars on the board holder when it is in position on the bar across the oscillating frame.

N.B. The anodes are fitted with white anode bags when shipped and these should not be removed. If by chance they come separately, please fit them over the anodes and tie them at the top.

2) Switch on the green mains **ON/OFF** switch which should illuminate.

3) Check all the functions are working by depressing all the function switches and in the case of the Clean/Condition (Tank 1), Catalyse (Tank 3), Salt Remover (Tank 4) and Copper (Tank 6), leave these switches on and allow the tanks to reach their operating temperatures of 60-65°C, 38-44°C, 40-50°C and 25-30°C respectively, when the orange indicator light will then go out.

N.B. It is important that these temperatures are correct and although factory set they could change depending on the ambient temperature.

If this is the case open the cabinet doors and you will see a white bracket fixed to each heated tank to which the thermostat controller is fixed. To alter the temperature turn the brass control spindle anti-clockwise to decrease and clockwise to increase.

N.B. If you decrease when the heater is on, the orange heater indicator light will go out and if you increase when the heater is off, the /orange indicator light will go on.

4) Leave the heated tanks on and preferably turn the unit off at the end of the day and leave standing overnight.

5) Check the next morning that there have been no leaks and ensuring all function switches are in the **OFF** positions empty the tanks through drain taps provided and remove any excess water in the bottoms with paper towels.

N.B. In all cases before filling the tanks make sure that the drain hose ratchet clips and drain taps are closed and that the taps have been clipped back into the clips provided.

PLATING LINE POWER SUPPLY CONTROL PANEL FUNCTIONS

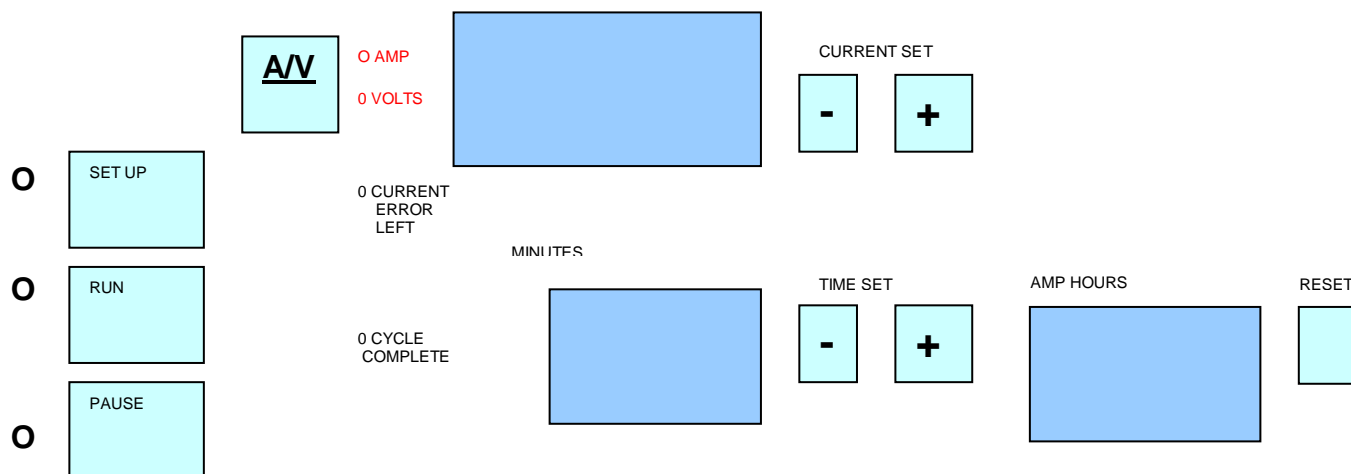

1. WHEN POWER IS SWITCHED ON THE RED LED NEXT TO THE SET-UP AND A/V SWITCHES LIGHT UP AND ALL THE DISPLAYS COME ON.

2. THE CURRENT VOLTAGE DISPLAY WILL BE IN AMPS MODE. PRESS THE CURRENT SET + AND - BUTTONS TO SET CORRECT CURRENT. IF THE A/V BUTTON IS PRESSED AGAIN IT WILL SHOW VOLTS.

N.B. THE CURRENT ERROR LIGHTS WILL COME ON WHEN YOU ARE DOING THIS.

3. SET THE TIMER THE SAME WAY.

4. WHEN YOU ARE READY TO PLATE PRESS RUN. THE PLATING CURRENT WILL BE MONITORED, THE RUN LED WILL ILLUMINATE, AND THE TIMER WILL COUNT DOWN AND THE AMP HOURS WILL START GOING UP.

5. IF AT ANY TIME YOU NEED TO REMOVE THE BOARD BEFORE PLATING HAS FINISHED PRESS THE PAUSE BUTTON (PAUSE LED ILLUMINATES). THIS WILL REDUCE THE CURRENT TO ABOUT 20% OF THE SET CURRENT AND STOP THE TIMER AND AMP HOURS. WHEN YOU PRESS RUN THE PROCESS WILL CONTINUE UNTIL THE TIMER REACHES 0.0. THE CYCLE COMPLETE LED WILL LIGHT UP AND THE BUZZER WILL SOUND.

6. BEFORE REMOVING THE BOARD PRESS THE SET UP BUTTON AND ALL METERS OTHER THAN AMP HOURS WILL GO BACK TO THEIR ORIGINAL SETTINGS.

7. THE AMP HOUR METER IS VERY USEFUL IN DETERMINING WHEN TO ADD THE ABC 6900 BRIGHTENER TO THE COPPER PLATING BATH. AS A GENERAL RULE, ADD 30ml OF ABC 6900 BRIGHTENER AFTER EVERY 100 AMP HOURS TO RESET HOLD THE BUTTON DOWN UNTIL METER RESETS (ABOUT 10 SECONDS).

G) Chemical Charge

The ABC chemicals supplied with the unit should be made up in the tanks as follows with Tank 1 being the first tank on the left hand side with the unit facing you.

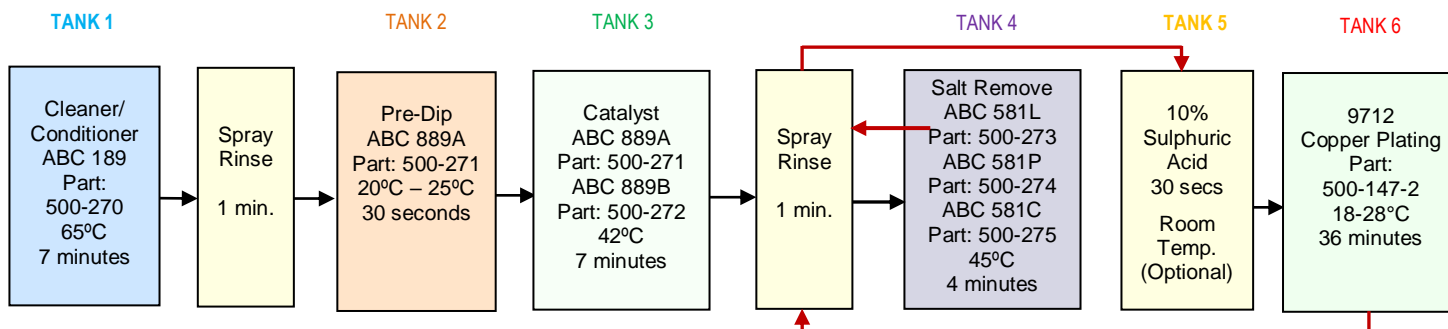

Tank 1. CLEANER / CONDITIONER: ABC 189 (part: 500-270)

Add 150ml ABC189 to 4850 ml of de-ionised water to make 5 Litres

Tank 2. PREDIP : ABC 889A (part 500-271)

Use as supplied

Tank 3. CATALYST: ABC 889A (part 500-271 & ABC 889B (part 500-272)

Add half of the contents of ABC 889A to the tank, then add 250 ml of the ABC 889B and top up to 10mm from top of the tank with the rest of the ABC 889A.

Tank 4. SALT REMOVER: ABC 581L (part 500-273), ABC 581P (part 500-274) & ABC 581C (part 500-275)

Put 2 litres of de-ionised water into the tank. Add 2.15 Litres of ABC 581L followed by 500ml of ABC 581P and then 50ml of ABC 581C. Top up to working level with de-ionised water.

N.B. Always ensure that chemicals are mixed in this order.

Tank 5. 10% SULPHURIC ACID (96-98%):

Please note this bath is optional. (See ABC Copper Plating Process Sequence – page 8) Also we do not supply the Sulphuric Acid, but leave you to buy it locally if necessary.

Tank 6. COPPER PLATING: ABC 9712 (part 400-147-2)

Use as supplied.

N.B. When putting left hand anodes in bath be careful not to damage the white heater rod.

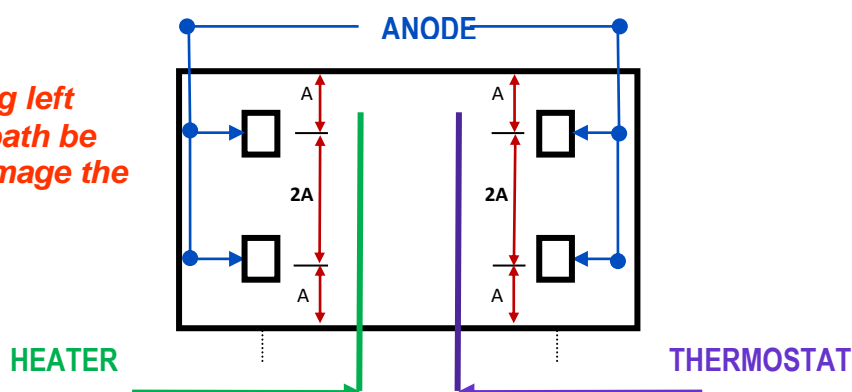

- For a new installation or if the anodes need changing, always make sure the tank is empty before placing the anodes in position. Also make sure Anode Bags are fitted and securely tied in place.
- Fill the tank with the ABC 9712 Copper Basis Solution so that when the plating line board holder is fixed to the bar across the tank the liquid level is 10mm below the round stainless steel board holder legs, **add the sodium chloride supplied in the test tube to the solution.** Place plastic balls provided on top of solution until surface is fully covered (These prevent splashing and evaporation).

- 1) Press the **SET UP** switch and set the current meter to 16 amps.
 - 2) Set the timer to 95 minutes.
 - 3) Reset the amp hour counter by holding the **RESET** switch down until the meter reads **0000**
 - 4) Place a (305x254mm) double-sided copper clad board in the board holder and put the board into the solution.
 - 5) Switch on the oscillator and pump buttons.
 - 6) Press the Run switch.
 - 7) When the timer has reached 0 go into **SET UP** again and then press **RUN**. This will ensure the solution has been properly electrolysed and at the end of the second cycle the amp hours should read about 50.
- For the PL904 systems use (457x305mm) double-sided board and set the current meter to 28 amps, then repeat steps 3-8. Amp hours should read about 95.

N.B.1. *In both cases scrub clean the copper surfaces before placing the board in the tank.*

N.B.2. *Always press the pause button before removing from, or placing the board into the solution.*

- 8) After solution has been electrolysed add 190ml of **ABC 6900 brightener additive** for PL903S and 380ml Brightener for PL904S, with the air pumps on to allow it to be thoroughly mixed into the solution. Go into 'Set Up' again and use the same settings but set the timer to 30 minutes and repeat 4 - 7 above.
- 9) Finally reset the AMP hour counter to **0000**

YOUR SYSTEM IS NOW READY FOR USE.

N.B.1. For plating line control panel functions see page 5.

BATH MAINTENANCE AND REPLENISHMENT

This is done on a m² basis of PC boards processed as follows:

1. CLEANER / CONDITIONER

After processing 2.5m² of boards add 15 ml of ABC 189 - For best results it is recommended to make-up a fresh bath every 3 months. Operating temperature 60°C – 70°C option 65°C

2. PREDIP

Top up losses due to Drag-out and evaporation with deionised water.

After processing 25m² of board - change the solution.

3. CATALYST

After processing 2.5m² boards – add 25 ml of ABC 889B. Solution should be changed after processing 60m² of boards.

N.B. Always place a blank piece of board in the tank and start the oscillation in order to ensure solution agitation during heat up time. Operating temperature: 38°C – 44°C **N.B. NEVER EXCEED 50°C**

4. SALT REMOVER

After processing 2.5m² boards add: 215 ml of ABC 581L + 50 ml of ABC 581P + 5 ml of ABC 581C

Solution should be changed after processing 100m² boards. Operating temperature 40°C – 50°C optimum 45°C

5. ABC 9712 COPPER PLATING TANK

Replenishment Procedure.

After every 100 amp hours, add 30ml of ABC CB6900 Brightener. (500-146-2).

Then reset the amp hour meter to Zero.

Copper plating bath should occasionally be emptied into its original supply container through a funnel with a coffee filter or similar placed in the funnel. If copper plating seriously deteriorates despite additions of Brightener and filtration as above, bath should be renewed or anodes/ anode bags may need replacing.

N.B. Owing to product improvement, the ABC 972 Leveller and Brightener has been replaced by :-

1 litre of ABC 6900 Brightener (part number 500-146-2). If you still have old chemistry – use as normal

The brightener can be used as an exact replacement and should be added at the rate of 30ml after every 100 amp hours.

If however your boards appear dull or grainy at the edges, then add 15ml of the ABC6900 before plating the next board. However still add the 30ml when 100 amp hours is displayed.

N.B. In all the baths any loss of liquid due to evaporation should be topped up using de-ionised water.

Except the Catalyst Tank which should be a mix 60% ABC889A Pre-dip (500-271)

with 40% de-ionised water. (IMPORTANT: Remember to mix pre-dip and de-ionised water before adding to tank).

Finally, please note the Starter Kit (part 500-159-2) now contains enough chemicals to replenish 10m² of boards.

ABC COPPER PLATING PROCESS SEQUENCE

1. Place an A4 size blank piece of FR4 Board (with the copper removed) in both the Catalyst and Salt Remover tanks. Then switch on the tanks and the oscillation. This will ensure that these two tanks heat up evenly.

When the required temperature have been reached, these blanks can be removed, rinsed, dried and stored until the process is next required to be used. Ensure you label each one, so that the same blank is used in the same tank every time.

2. Cut and drill an 18 micron copper clad double-sided board so that borders are allowed for as shown below.

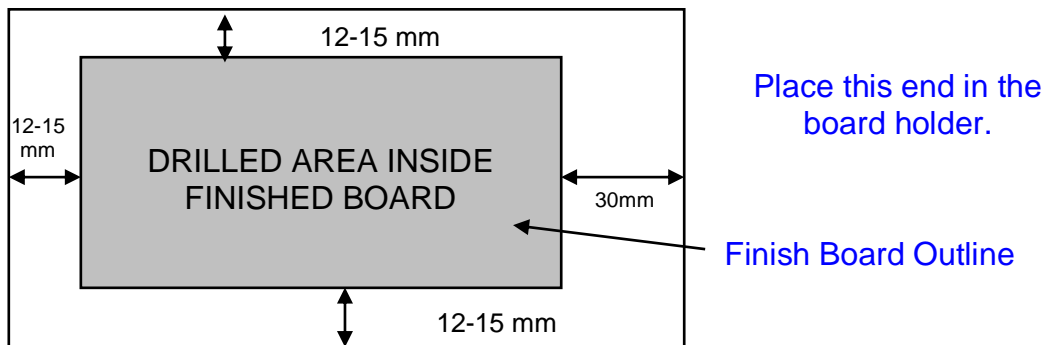

3. Immerse board in 1st process tank which contains the **ABC 189 Clean/Conditioner** for 7 minutes. Tank temperature should be 60 - 65° C.

4. Spray rinse immediately for 1 minute then place it in the 2nd process tank which should contain the **ABC 889A** pre-dip for 30 seconds - and operate at room temperature.

N.B. In all spray rinses ensure you move the board up and down between the spray bars and the board holder is also thoroughly washed in the area where it could come into contact with chemicals.

5. Then without rinsing place board in 3rd process tank (**ABC 889A & ABC 889B Catalyst**) for 7 minutes. Remove board having first allowed excess chemical to drain off the board back into the tank. Tank temperature 38 - 44°C. DO NOT EXCEED 50°C.

N.B. Never allow any ABC 189 to be transferred to the ABC Catalyst Bath. If this has happened, you will firstly see the appearance of voids. Then bath decomposition at a later stage.

6. Spray rinse for 1 minute.

7. Place board in 4th process tank (**ABC Salt Remover**) for 4 minutes. Tank temperature 40 - 50°C.

8. Remove and spray rinse for 30 seconds.

9. Normally it is possible to go from step 8 directly to step 10. However we have found from time to time that on examining the board after it has been in the copper bath for 3-4 minutes a brown sludge has formed on the surface. If the board is removed from the bath at this point the sludge can be wiped off and the board placed back in the bath and normal plating will take place.

The other option to ensure that this does not happen is place the board for 1 minute in tank 5 (10% Sulphuric Acid) at room temperature and then place the board directly into the Copper Bath (Tank 6) Step 1

10. Turn on the air pump switch and place board in 6th process tank (**ABC 9712 Copper Plating**) and plate at 3 amps per dm² of surface area for 36 minutes.

For example if you had a 25.0cm c 25cm panel then you would set the current at 37.5 amps (18.75 amps per side) Tank temperature 20-30°C.

The current calculation is as follows:- $\frac{X\text{cm} \times Y\text{cm} \times 6}{100}$ panel

11. After plating **immediately** remove board from solution and spray wash for 15 seconds then dry with paper towels and hot air immediately to avoid the copper surface oxidising.

12. Any liquid level losses caused by evaporation and drag out should be topped up with deionised /distilled water in all tanks, other than the catalyst which should be topped up with 60/40% mixture of ABC 889A (60%) and deionised/ distilled water (40%).

13. When not in use ensure lids are in place.

14. From time to time slide the anode hooks backwards and forwards along the anode rails to ensure you have a good contact. Make sure anodes are placed back in their original position.

NB. Before starting always make sure that the liquid level is 10-15mm from the top for tanks 1-5 and for plating tank 10-15mm below the bottom of the board holder when in position.

GENERAL FAULT FINDING COPPER PLATING

FAULTS	CAUSE	CORRECTION	ADDITION	
			MIN	MAX
Roughness	Suspended Particles	Filter solution and/or plate a dummy 12"x10" panel at 1amp/dm ² for 1 hour		
Burning	Lack of Brightener	Add 6900 Brightener	10ml	30ml
	Low Temperature	Check Temperature	20°C	30°C
	Poor Agitation	Make sure oscillation is taking place		
	Poor Air Bubble pattern	Make sure you have good bubble pattern Check no pipes blocked or air pumps are faulty		
	Current too High	Check it is 3 amps / dm ²		
Dullness on all copper areas	Lack of Brightener	Add 6900 Brightener	10ml	30ml
Bright on outside edges of board. Dull in the Middle.	Too much Brightener	Plate large blank at 3 amps / dm ³ for 3 –4 hours Repeat if board is not bright all over		
Bright in the middle of the Board dull at edges.	Lack of Brightener High temperature	Add 6900 Brightener Check temperature – should be between 25°C – 30°C	10ml	30ml
Faults not corrected by above procedure	Organic Contamination	Change solution. Store contaminated solution in its original container and send 100mls of it back for analysis.		
Crazing Effect or Patchy Appearance	Chloride level too low	Add Conc. Hydrochloric Acid reagent grade 36% or laboratory grade sodium chloride	3ml 1 gram.	4ml 2 gram.
Current Error light on when Power supply is in Run Mode or Voltage high (clips at 3.5 volts) and set current starts to decrease	Poor contact	Check anode hooks are in proper contact by sliding anodes backwards and forwards on anode rails and remove any copper deposits around anode hooks		
	Anode Polarisation	Check anodes still have an even black oxide layer over their surface. If they no longer have black layer or are a grey to whitish colour they have become polarised. If so remove and scrub thoroughly clean with water and detergent. Rinse and put back in bags and then return to bath Plate large panel at 1.0 amp / dm ² for 120 minutes If anodes have a black oxide layer over their surface and problem persists, remove the anode bags and thoroughly wash in hot soapy water. If problem still persists change the bags.		
	Anodes badly worn	Replace anodes.		

WARNING: NEVER ALLOW ANY SOLUTION TO GO BELOW 0°C

The Mega Method for producing Printed Circuit Boards

A

CONVENTIONAL SINGLE OR DOUBLE SIDED BOARDS

- 1) First place a piece of drill exit board 1.5mm thick on the CNC base against the metal stops in the X and Y axis
- 2) Tape the Drill exit board in place.
- 3) Cut a piece of Copper clad board (35 microns copper) slightly bigger than your finished board with the Model 45 shear.
- 4) Tape the board onto the exit board, so that it is near to the x and y metal stops - See below:

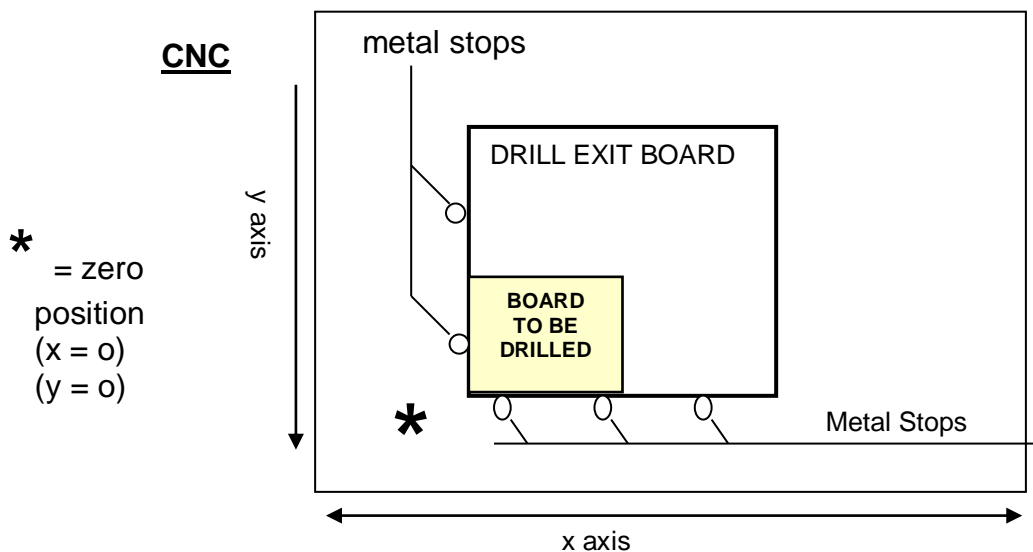

- 5) When all the holes have been drilled remove the board.
- 6) This will mean that the bottom left hand corner will then be near the x and y zero of the machine. Load the required Excellon drill file which has been created by your CAD package. Check that the co-ordinates of the first and last holes to be drilled in the x and y direction appear to be to the correct scale and also if the two minimum co-ordinates are near the x and y zero. i.e. say $x > 10$ and $y > 10$ mm. Therefore this will mean that with the offset being $x = 0.000$ $y = 0.000$ the board to be drilled will be in the correct location. If however the minimum co-ordinates had been say $x > 90$ and $y > 90$, then you would need to put in offsets of $x = -80$ and $y = -80$. Select the drill sizes you need and start the drilling programme.
- 7) Scrub clean the surface of the copper with a wet Scotchbrite pad and then wash thoroughly to ensure all surfaces and holes are free from dirt. Then dry with paper towel and hot air.

8) Feed the board through the dry film laminator having first ensured that the laminator is up to temperature and you have run about 25cms of film through the machine before feeding the board in. **N.B.** Trim off all excess dry film around the edges of the board.

9) Remove the board and allow it to cool down for about 5-10 minutes in the black bag, drawer or subdued light.

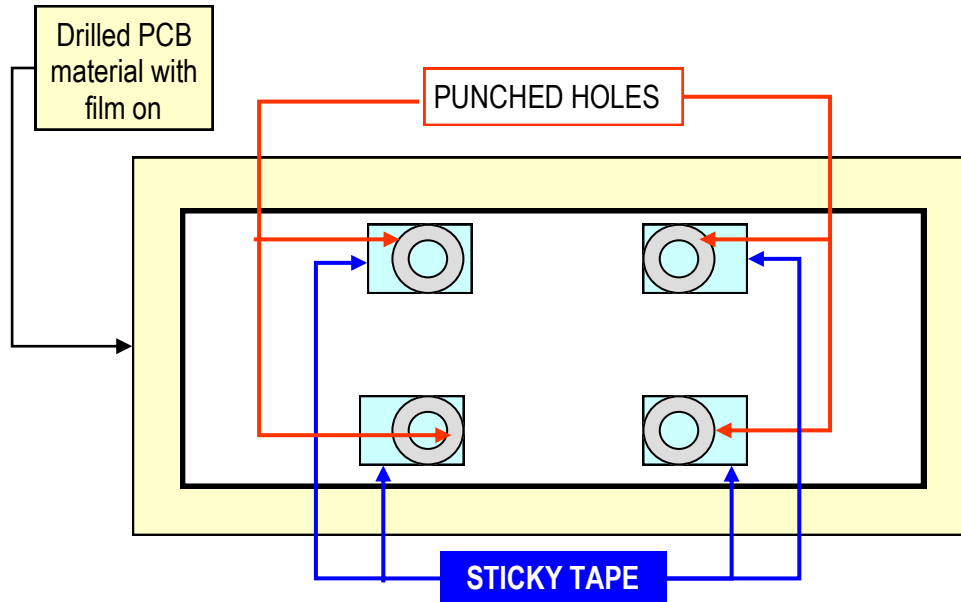

10) Take a negative of your PCB artwork pattern which has no hole centre and make four holes with a paper punch or scalpel, just outside the long borders of the finished board size. Stick Sellotape or similar over the holes on the side of the film that will not be in contact with the board.

11) Place your artwork over the Dry film covered copper surface and register the holes with the artwork by eye. When the best fit is achieved press the holes covered with sticky tape, down on to the board to hold the artwork in place. Repeat for the other side of the board.

12) Switch on the double-sided exposure unit and run it for 3-4 minutes to ensure the tubes are warmed up. Then place the board and artwork in the unit – set the timer for 15 seconds and then close the lid and press the 'START' button.

13) Remove exposed board from the exposure unit and after 3-4 minutes peel off the clear protective film. You will have a dark blue image of your layout on a light green background.

14) Place the board in the PB710 Developing tank. After 3 minutes agitate the board by moving it up and down in the solution, until all the light green background has disappeared. For best results, especially with fine lines use one of our spray developers

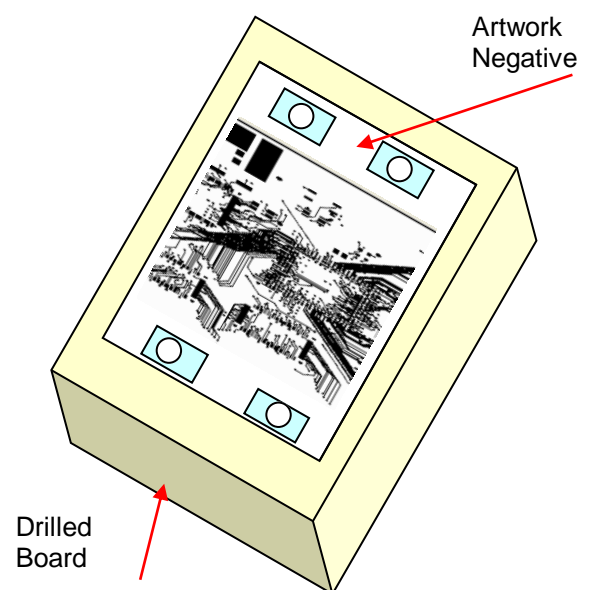

- 15) Spray wash thoroughly.
- 16) Bubble etch until all unwanted copper has been removed about 6 - 7 minutes. Rotate halfway through cycle. For sharper, faster etch, use one of our spray etchers. (Etching time 60-90 seconds).
- 17) Spray wash thoroughly.
- 18) Resist strip dry film photoresist 2 - 3 minutes.
- 19) Spray wash thoroughly.
- 20) Remove board from basket and whilst still wet, scrub copper surface with abrasive pad e.g. Scotchbrite pad and rinse scrubbed board thoroughly.
- 21) Place board in immersion tin tank for 10 - 15 minutes.
- 22) Remove board, rinse firstly in hot water (45 - 50°C) and secondly cold water. Then dry board with paper towels and a hair dryer.
- 23) Using Model 45 Guillotine, cut board to finished size.

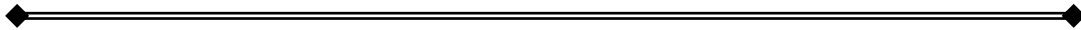

B

PANEL PLATED THROUGH HOLE BOARDS

- 1) Using 18 micron FR4 Double sided board material - repeat Steps 1 to 7 as for conventional boards.
- 2) Place board in the Plating Line (PL903) board holder and switch on oscillating motor.
- 3) Fix the board holder in position over the ABC 189 Clean / Condition tank (tank 1) containing ABC 189 clean conditioner and leave in the solution for 7 minutes.
- 4) Remove holder from oscillating frame and thoroughly spray wash the board and the bottom part of the holder (1 minute).
- 5) Fix the board holder in position over the ABC Pre-dip tank (tank 2) and leave for 30 seconds.
- 6) Fix the board holder in position over the ABC Catalyst tank (tank 3) and leave in the solution for 7 minutes.
- 7) Remove holder and board having allowed all Catalyst to drain back off the board into the tank.
- 8) Spray wash for 1 minute
- 9) Fix the board holder in position over the ABC Salt Remover Tank (tank 4) and leave in the solution for 4 minutes.

- 10) Spray wash for 1 minute.
- 11) You would now normally place the board in the copper plating tank (tank 6). However we have found from time to time that on examining the board after it has been in the copper bath for 3-4 minutes a brown sludge has formed on the surface. If the board is removed from the bath at this point the sludge can be wiped off and the board placed back in the bath and normal plating will take place. The other option to ensure that this does not happen is to first place the board into Tank 5 (10% Sulphuric Acid) at room temperature for 1 minute and then place the board directly into Copper Plating Tank (tank 6) without rinsing it.
- 12) Measure board area in square cms. then fix the board holder over the ABC 9712 Copper Plating tank (tank 6) containing the copper plating solution.
- 13) Calculate the plating current to be set as follows:-
$$\frac{\text{board area in sq. cms} \times 6 \text{ amps}}{100}$$
- 14) In Setup Mode set current to value in (13).
- 15) Set timer to 36 minutes.
- 16) Press 'PUMP' switch on for air to bubble through solution.
- 17) Press 'RUN' button.
- 18) When timer reaches 0 and buzzer sounds immediately remove the board and holder from solution.
- 19) Spray wash for 15 seconds
- 20) Remove board from holder - tap it against edge of wash tank to remove excess water from the holes, then quickly dry the board with paper towels to remove most excess water and then hot air.
If board shows any signs of brown oxidation, place it in the cleaner / conditioner tank for 10 seconds, then wash and dry it again as above.
- 21) Follow stages 8 to 23 as for conventional Boards in 'A'.

N.B. *Always ensure that when the board is in any of the ABC process Tanks (Tanks 1 - 5) the oscillating frame switch is 'ON'*



Printed Circuit Board Production

FLOW CHART FOR PRODUCING SINGLE, DOUBLE SIDED AND PLATED THROUGH HOLE BOARDS

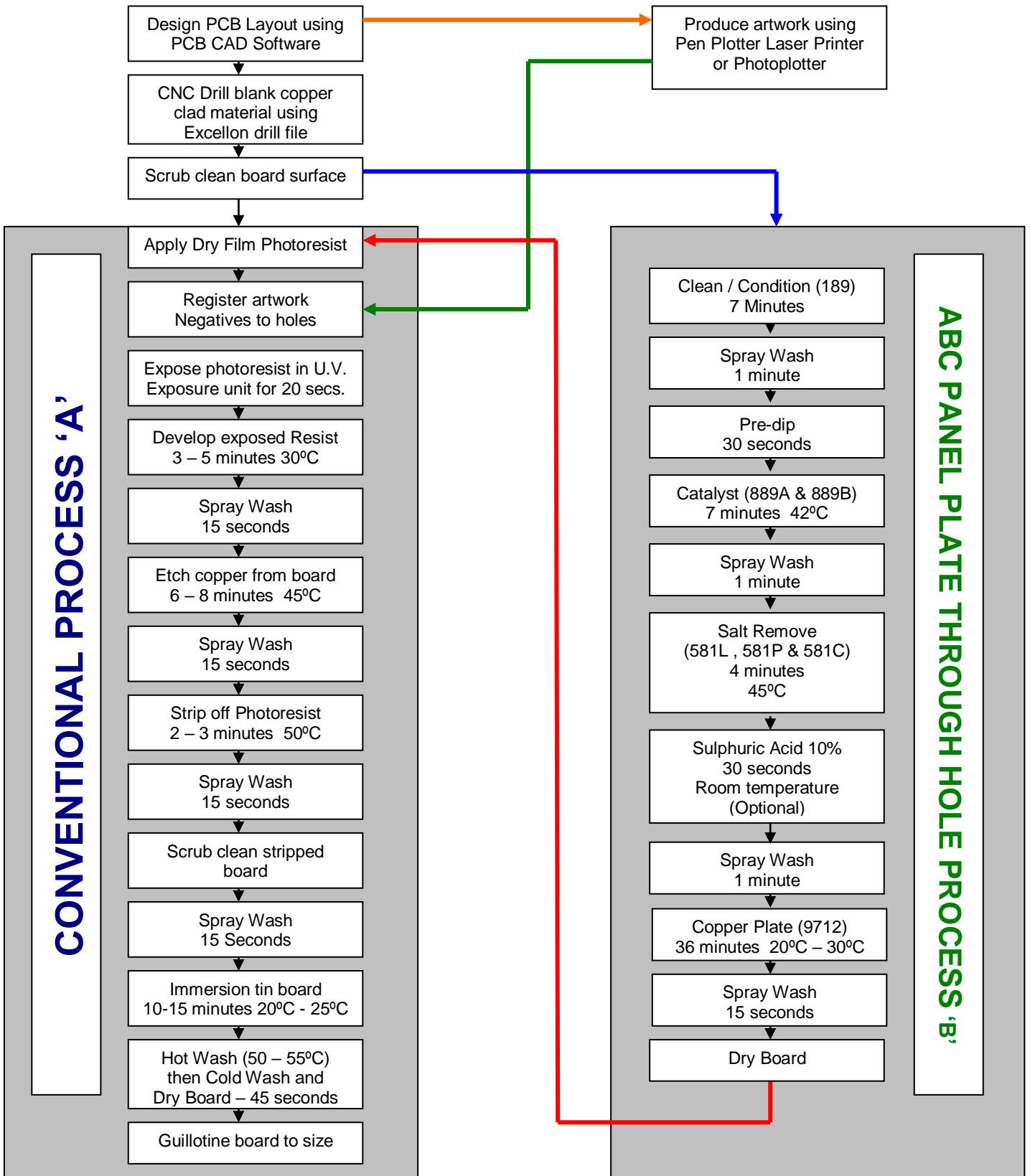

ENVIRONMENT PROTECTION



Recycle unwanted materials instead of disposing of them as waste. All equipment, accessories and packaging should be sorted, taken to a recycling centre and disposed of in a manner which is compatible with the environment.